

Ariel CO1008 Contemporary European Toilet with Dual Flush

- GPF 1.585
- Waste Pipe Diameter: 2"
- Waste Pipe Rough-IN: 12"
- Water Supply Thread: 4"
- Water Supply Location (measurement from side of the toilet) LEFT 4"X 14.5"
- Width of rear of toilet at 6 -inches from floor: 14"
- Shut-off valve clearance from centerline measured 6" from floor: 7" (+3")
- Waste Pipe Connection: Ceramic Mold Pipe
- Flush Location: Top
- Flush Type: Dual
- Soft Close: Yes
- Siphonic Jet Feature: Yes



Nominal Dimensions

- Bowl Height: 16"
- Overall Depth: 29"
- Overall Width: 15"
- Overall Height: 32"

Dimensions:

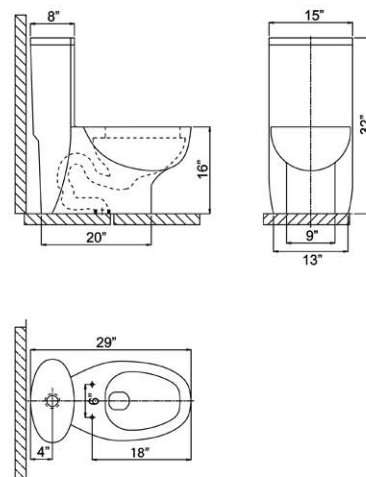

NOTES:

THIS COMBINATION IS DESIGNED TO ROUGH-IN AT A MINIMUM DIMENSION OF 305MM (12") FROM FINISHED WALL TO C/L OF TOILET. DIMENSION SHOWN FOR LOCATION OF SUPPLY IS SUGGESTED, SUPPLY NOT INCLUDED WITH FIXTURE AND MUST BE ORDERED SEPARATELY

IMPORTANT: Dimensions of fixtures are nominal and may vary within the range of tolerance established by ANSI Standard A112.19.2 These Measurements are subject to change. No responsibility is assumed for use of superseded or voided pages.

TOOLS NEEDED (NOT SUPPLIED)



INSTALLATION

First, attach the toilet seat to the toilet bowl. This will allow you to easily access around the toilet, if needed, while installing the toilet seat and toilet seat mounting hardware. Be careful not to scratch or damage any of the surrounding surfaces.



Take the toilet seat mounting hardware, screws, screw anchors and disassemble them, if not already done from the factory. Place the screw through the top side of the toilet seat hinge. Attach the anchor to the screw and lightly screw together.

Place the toilet seat into position while aligning the anchor and screw through the toilet seat mounting hole, on the top surface of the bowl. Align the toilet seat and tighten the screws to ensure proper fitment. Tightening the screws will expand the anchors to fill the holes and hold the toilet seat into place.

Slide the screw covers over the hinges, covering the screws



Set the toilet in the exact location of usage. Using masking tape or a non-permanent marker/pen/pencil, outline the footprint of the toilet onto the mounting surface. Also, mark the exact locations, directly below the toilet skirt mounting holes, onto the mounting surface. This will give you the reference point from which to measure and install the toilet mounting hardware.

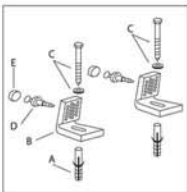

Toilet Mounting Bracket Hardware:

- A) Bracket bolt anchor
- B) Mounting bracket
- C) Bracket bolt and washer
- D) Skirt screw and decorative cap anchor
- E) Decorative cap (screw cover)

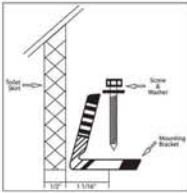

Remove the toilet and measure the thickness of the toilet skirt. It should be about 1/2-inch thick. Each toilet is slightly different, so it is best to measure the exact thickness of your specific toilet.

Measure the toilet mounting bracket from the outside measurement to the center hole. It should be about 1 1/16-inch.

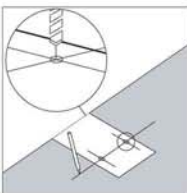

Add both these measurements together and use that combined measurement to mark the location of the toilet mounting bracket onto the toilet mounting surface. Use that combined measurement and reference point of the outlined footprint and skirt mounting holes. Measure 90-degrees (perpendicular) from the outlined footprint of the toilet, inward, towards the waste drain. Mark and drill the location of the toilet mounting bracket bolt into the mounting surface using a 5/16-inch drill bit.

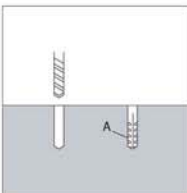

Place the bolt anchor inside the drilled hole and bolt the mounting bracket onto the mounting surface.

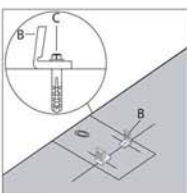

Bolt mounting hardware onto the mounting surface, using the newly drilled holes and place the wax gasket onto the waste pipe.

Note: Any other type of bolting system the installer may feel is safe to use for various types of installations may be used in place of the manufacture supplied bolt/washer/anchor hardware.

ARIEL

SKIRTED TOILET INSTALLATION

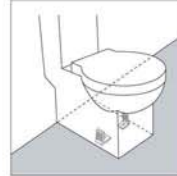

Carefully place the toilet into position, over the mounting brackets, without damaging the mounting brackets or deforming the wax gasket enough to not create a proper seal.

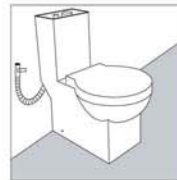

Connect a water supply hose (not supplied) from your water shut-off valve (not supplied) to the toilet. 1/2-inch National Pipe Thread (NPT).

Note: To ensure no water leaks, please tighten all water connections. Make sure hose-gaskets and plumbers-tape are used. Also check the water supply valve assembly for tightness. This may come loose during shipping or installation.

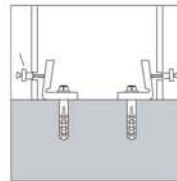

Carefully check the alignment of the toilet. Placing full body weight (100+ pounds) onto the center of the toilet, to set the seal of the wax gasket, and install the remainder of the toilet mounting hardware onto the toilet. Place the skirt screws through the decorative cap anchor, screw the skirt screws into the mounting bracket, through the toilet skirt holes.

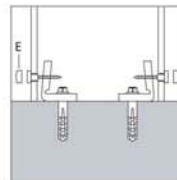

After tightening the skirt screws, place the screw covers over the screw anchors, covering the screws.



Turn on the water to check water flow and level. Adjustments of the water level can be made. Install tank cover and check toilet for proper function and for any leakage.

If the wax gasket did not seal, check the condition of the wax gasket and reinstall with more weight on top of the toilet to set the seal, before mounting the toilet to the toilet mounting brackets.

MAINTENANCE

- 1) Do not flush any large or hard trash through the toilet, as it may clog the toilet.
- 2) Wash the flush holes around the inside trim of the bowl, regularly.
- 3) Do not use abrasive cleaners or solvents to clean the toilet.
- 4) Do not impact the toilet with hard objects.
- 5) Close the toilet seat and cover, slowly and lightly.