

Ariel CO1038 Contemporary European Toilet

- GPF: 1.585
- Waste Pipe Diameter: 2"
- Waste Pipe Rough-IN: 12"
- Water Supply Thread: 4"
- Water Supply Location (measurement from side of the toilet): LEFT 4" X 14"
- Width of rear of toilet at 6 -inches from floor: 13.75"
- Shut-off valve clearance from centerline measured 6" from floor: 6.875" (+3")
- Waste Pipe Connection: Ceramic Mold Pipe
- Flush Location: Top
- Flush Type: Dual
- Siphonic Jet Feature: Yes



Nominal Dimensions

- Bowl Height: 16"
- Overall Depth: 28"
- Overall Width: 15"
- Overall Height: 32"

Dimensions:

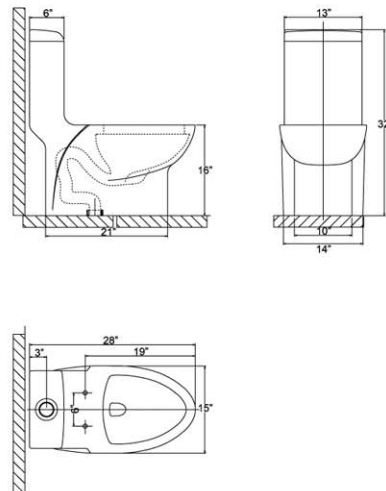

NOTES:

THIS COMBINATION IS DESIGNED TO ROUGH-IN AT A MINIMUM DIMENSION OF 305MM (12") FROM FINISHED WALL TO C/L OF TOILET. DIMENSION SHOWN FOR LOCATION OF SUPPLY IS SUGGESTED, SUPPLY NOT INCLUDED WITH FIXTURE AND MUST BE ORDERED SEPARATELY

IMPORTANT: Dimensions of fixtures are nominal and may vary within the range of tolerance established by ANSI Standard A112.19.2. These Measurements are subject to change. No responsibility is assumed for use of superseded or voided pages.

ARIEL





STANDARD FLOOR BOLT SKIRTED TOILET INSTALLATION

To ensure the proper installation of this product, please read the following instructions carefully before you begin. Be sure your installation conforms to local codes.

REMOVE OLD TOILET: Close toilet water supply valve and flush the toilet. Sponge any remaining water from the bowl. Disconnect and remove the external water supply line. If replacing valve, shut off the main water supply first. Remove mounting bolts and lift bowl off toilet flange. Plug waste opening to prevent sewer gas from escaping. Clean away old wax, etc. from installation area.

Before Beginning: Assuming that your bathroom has a four inch drain with a slotted closet flange and water supply line in place, to complete your installation you will need the following items, not supplied: two closet bolts, wax ring or bowl gasket, water supply hose and water shut off valve. **Caution:** The new toilet is made of fine vitreous china like the best quality tableware. It is ruggedly constructed, however, extra care should always be exercised during the installation of any product with a fragile finish when rough handling and the potential danger of dropped tools threaten to chip or crack the finish. **Water Supply:** If your water line is through the wall, install an Angle Stop. If it is through the floor, install a Straight Stop.

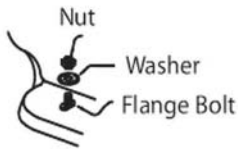
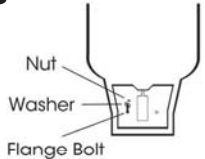
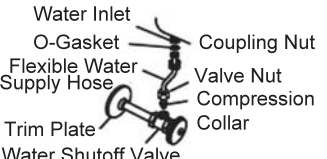
Installing the Toilet

<p>1</p>  <p>Clean the immediate floor area thoroughly. Insert new toilet bolts in the slotted flange, bolt heads down. The toilet should be placed on the floor upside down, on soft material to prevent scratching. Place the slightly warmed wax ring in the circular recess in the base of the bowl.</p>	<p>2</p>  <p>Unplug the floor waste opening. Gently place the bowl, right side up, in position with the toilet mounting bolts protruding through the holes in the toilet base. Press down, with a slight twisting motion, on the top center, with your full weight. Make sure the toilet is as level as possible. If needed, you can use wedges under the rim of the pedestal base to help leveling.</p>	<p>3A NON SKIRTED</p>  <p>Place the washers (Marked: This Side Up) and nuts on the bolts. Alternately finger tighten then 1/2 turn with a wrench. DO NOT OVERTIGHTEN NUTS AS THE CHINA WILL CHIP OR CRACK. Pour water into bowl to prevent the escape of sewer gas. Trim bolt height if required, to place caps. Wipe away any excess sealant at pedestal base along floor line.</p>
<p>3B SKIRTED REAR OF TOILET</p>  <p>For toilets that have optional mounting holes behind the bowl assembly, you can use the open work space available to reach behind the toilet bowl, and ratchet bolts down to mount the toilet to your mounting surface. Another Option is to use a non-hardening adhesive, such as silicone glue, to adhere the outer-most edge of the underside of the toilet down into your mounting surface. It is not recommended to glue more than about 2-inches in side the outermost perimeter of the toilet, as it will be more difficult to remove later, if needed. A putty knife can be run about the perimeter of the toilet can be used to easily cut the seal between the toilet and mounting surface.</p>	<p>4</p>  <p>Connect the cold water line to the tank with your straight or angle stop. Place the washer, then the plastic nut on the tank end of the connecting pipe and bend the pipe to fit into the inlet hole on the water regulator. Tighten all coupling nuts securely. * Do not use Plumbers Putty!</p>	<p>5</p>  <p>On certain models the flush lever must be installed. To do this, remove the lever from the parts bag. Insert the lever through the hole in the tank. Thread the nut from the parts bag into the threaded shank. NOTE: If the lever is located on the left side of the tank, the threads are left-handed. To tighten, turn the nut counter-clockwise. For tank models that have the lever located on the right side, install in the same way except this assembly has a right-hand thread, (Turn clockwise.) Tighten nut with wrench to achieve a snug fit.</p>

CARE AND CLEANING

Your new toilet is made of stain, acid and abrasion resistant vitreous china. But, like all fine finishes the china requires reasonable care. For day-to-day cleaning, wash with warm water, a soft cloth, and a mild detergent such as Handy Andy, Mr Clean or Lestoil. On stubborn stains, use one of the powdered detergents such as Spic & Span, on a damp sponge or scouring pad of nylon, saran, or polyethylene. Never use abrasive scouring powders, cleansers, or pads as they tend to create microgrooves that dull the finish and allow dirt to work into the surface. Use of tank cleaning products containing calcium hypochlorite (chlorine) or any other reactive chemical shall constitute improper maintenance.