

TAYLOR 66" SINGLE SINK BASE CABINET



BASE CABINET DIMENSIONS

66" W x 21.6" D x 34.5" H



FEATURES

- Solid wood frame & plywood panels
- Dovetail drawers and joints
- Soft closing doors & drawers

HARDWARE FINISHES*



Brushed Nickel Satin Brass Matte Black Polished Chrome

Hardware comes preinstalled with the illustrated option. Other finishes are available on our online store if you prefer a different one.

AVAILABLE COLORS



White Grey Midnight Blue

FRONT VIEW

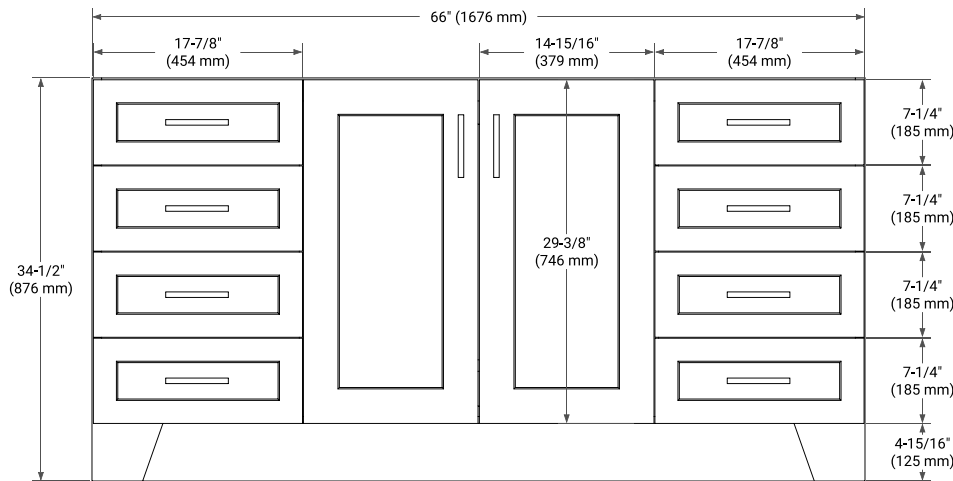

SIDE VIEW

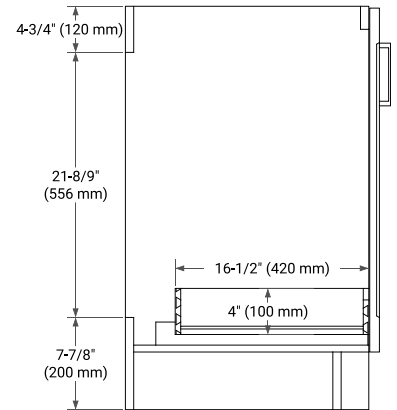

PLAN VIEW

