



BASE CABINET DIMENSIONS

60" W x 21.5" D x 33.5" H

FEATURES

- Solid wood frame with engineered wood panels
- Dovetail drawers and joints
- Soft closing doors & drawers

HARDWARE FINISHES



Brushed Nickel Satin Brass Matte Black Polished Chrome

AVAILABLE COLORS



White Grey

FRONT VIEW

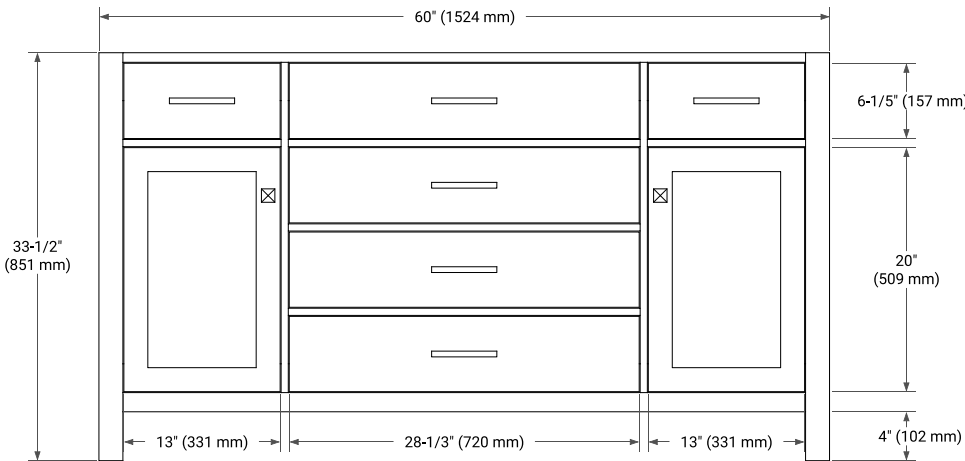

SIDE VIEW

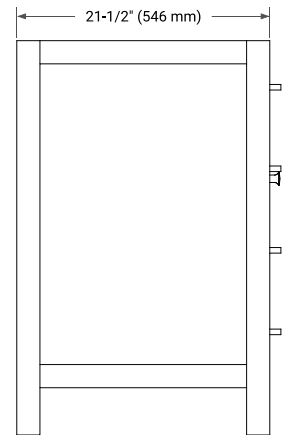

PLAN VIEW

