



BASE CABINET DIMENSIONS

60" W x 21.5" D x 34.5" H

FEATURES

- Solid wood frame and Plywood
- Soft-close system
- Dovetail construction
- Ample storage

HARDWARE FINISHES



Brushed Nickel Matte Black

AVAILABLE COLORS



White Grey Midnight Blue White Oak

FRONT VIEW

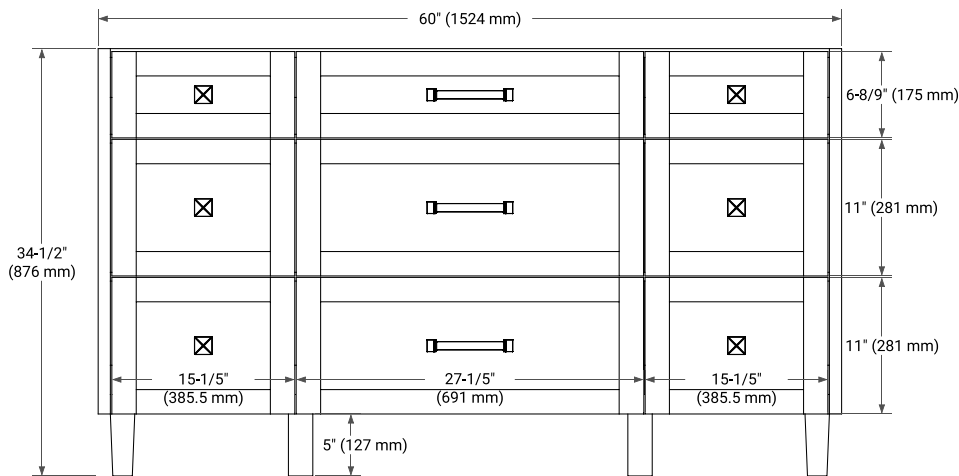

SIDE VIEW

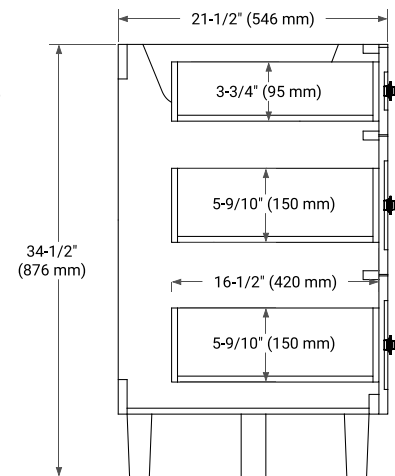

PLAN VIEW

